

Fittings with short Spigot

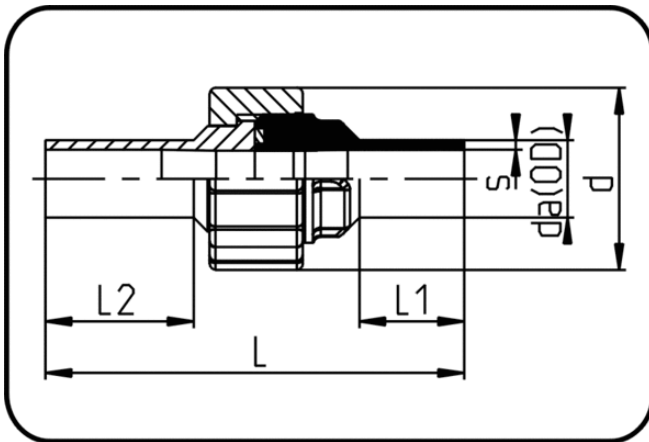

Code: 024

- Union Type 24
- FPM-sealing
- injection moulded
- **Butt-welding**
- **PE 100-RC black**

Dim. 75 and 90 with PVDF-Union nut.

Dimension	Code	Detail	da(OD) mm	s mm	L mm	L1 mm	L2 mm	d mm	Weight
20	70.024.0120.11	20 SDR11 ISO S-5	20	2	108	24	38	47	0.05
25	70.024.0125.11	25 SDR11 ISO S-5	25	2,3	114	24	39	57	0.08
32	70.024.0132.11	32 SDR11 ISO S-5	32	3	120	25	39	64	0.11
40	70.024.0140.11	40 SDR11 ISO S-5	40	3,7	128	25	42	78	0.18
50	70.024.0150.11	50 SDR11 ISO S-5	50	4,6	133	25	44	89	0.24
63	70.024.0163.11	63 SDR11 ISO S-5	63	5,8	138	25	44	109	0.39
75	70.024.0175.11	75 SDR11 ISO S-5	75	6,8	132	28	37	130	0.66
90	70.024.0190.11	90 SDR11 ISO S-5	90	8,2	133	35,5	57	130	0.65