

Pipes

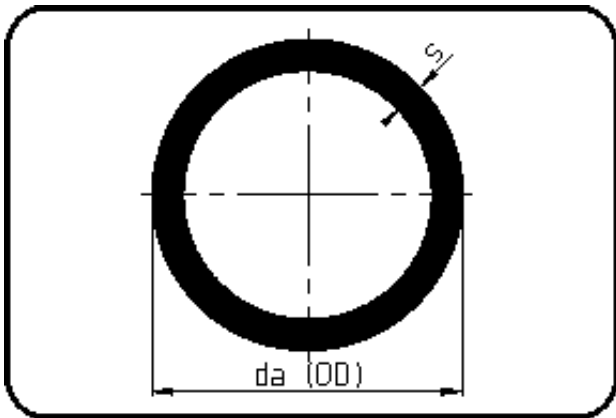

- Pipe 5m
- flame retardant
- extruded
- PPs grey

Dim. 110 - 160 SDR11 Discontinued products.

Dimension	Code	Detail	Weight
75	17.705.0075.11	75X6,8 SDR11 ISO S-5	1.44

	Unit	Nominale	Tol-	Tol+
da(OD)	mm	75		
s	mm	6,8	0	0,9