

Pipes

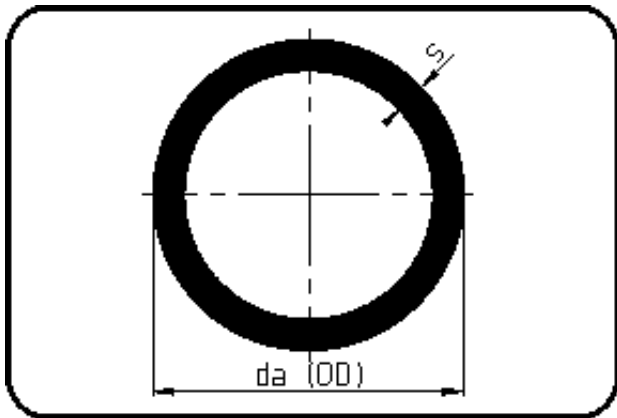

- Pipe 5m
- flame retardant
- extruded
- PPs grey

Dim. 110 - 160 SDR11 Discontinued products.

Dimension	Code	Detail	Weight
25	17.705.0025.11	25X2,3 SDR11 ISO S-5	0.168

	Unit	Nominale	Tol-	Tol+
da(OD)	mm	25		
s	mm	2,3	0	0,5