

# Operating Instructions

Type: MEK-32 / MAK-32

Serial No.: \_\_\_\_\_

Article No.: \_\_\_\_\_

**⚠** These operating instructions contain important information to be observed for hand extruder operation and maintenance.

It is therefore imperative that they be read and their contents fully understood by the operators before the hand extruder is placed in service.

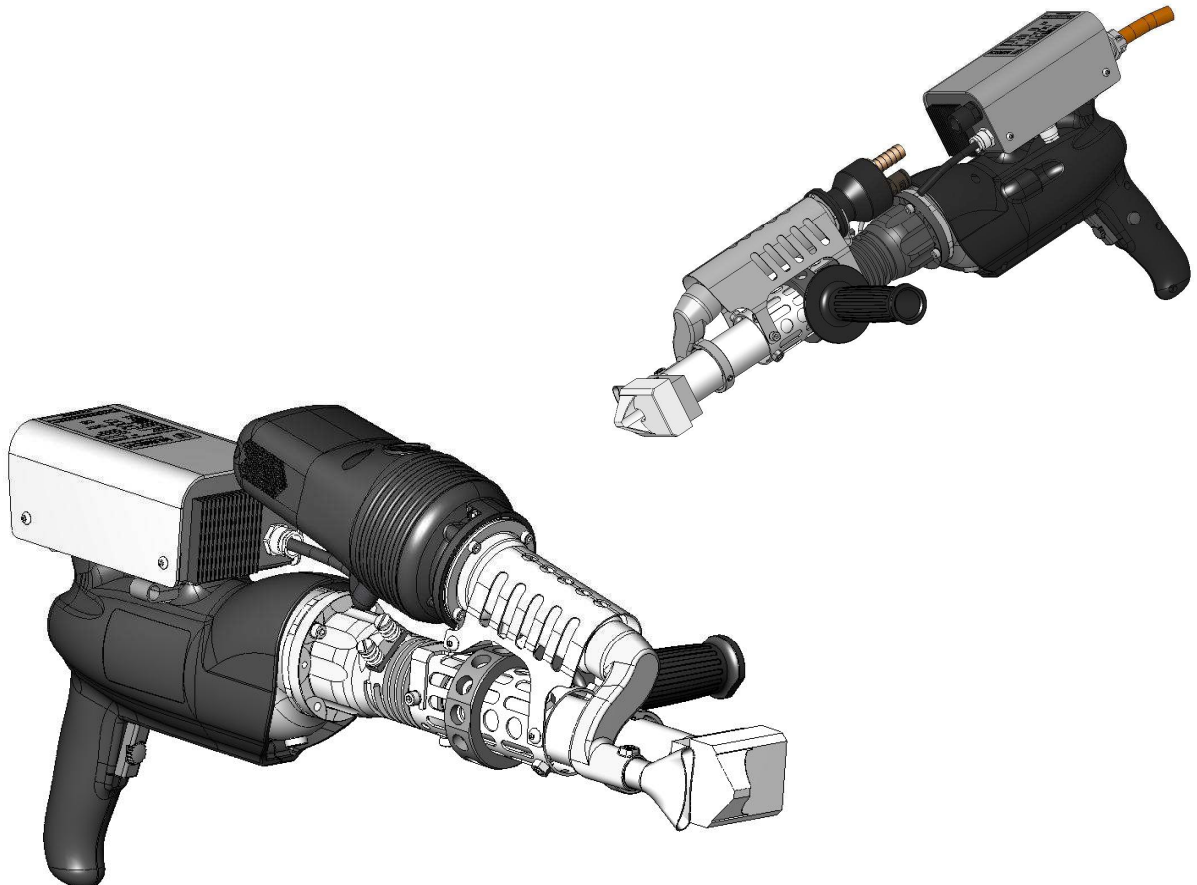

# Hand Extruder MEK-32 / MAK-32

---

## Scope of delivery:

Please check that the delivery is complete.

The delivery comprises:

1 hand extruder	1 extruder stand
1 handle	
1 welding shoe, machined	
3 preheat nozzles	
1 hot air hood	

## Contents

<b>1</b>	<b>GENERAL</b> .....	<b>4</b>
<b>2</b>	<b>SAFETY</b> .....	<b>4</b>
2.1	IDENTIFICATION OF INFORMATION IN THE OPERATING INSTRUCTIONS .....	5
2.2	PERSONNEL QUALIFICATION AND TRAINING .....	5
2.3	RISKS RESULTING FROM NON-OBSERVANCE OF THE SAFETY INSTRUCTIONS .....	5
2.4	SAFE WORKING PRACTICES .....	5
2.5	SAFETY INSTRUCTIONS FOR OPERATOR / OPERATING PERSONNEL .....	5
2.6	SAFETY INSTRUCTIONS FOR MAINTENANCE, INSPECTION AND MOUNTING .....	7
2.7	UNAUTHORIZED MODIFICATIONS AND SPARE PARTS .....	7
<b>3</b>	<b>TRANSPORT AND STORAGE</b> .....	<b>8</b>
3.1	TRANSPORT .....	8
3.2	STORAGE .....	8
3.3	RETURN TO MUNSCH .....	8
<b>4</b>	<b>PRODUCT DESCRIPTION</b> .....	<b>8</b>
4.1	APPLICATION RANGE .....	8
4.2	GENERAL .....	8
<b>5</b>	<b>STARTUP AND SHUTOFF</b> .....	<b>9</b>
5.1	GENERAL .....	9
5.2	PREPARATION .....	9
5.3	STARTING THE HAND EXTRUDER .....	10
5.4	WELDING WITH THE HAND EXTRUDER .....	11
5.4.1	Introducing the welding rod .....	11
5.4.2	Replacement and aging of welding rod .....	11
5.4.3	Welding direction / rate .....	11
5.4.4	Interruption of work .....	11
5.4.5	Shutoff .....	12
5.4.6	Transport/Storage .....	12
5.5	SET TEMPERATURES ON TEMPERATURE CONTROLLER .....	12
5.5.1	Set temperatures .....	12
<b>6</b>	<b>MAINTENANCE/INSPECTION</b> .....	<b>14</b>
6.1	MAINTENANCE/INSPECTION OF MEK/MAK HAND EXTRUDER .....	14
6.2	DISMANTLING .....	14
6.2.1	Overview of spare parts/attachments .....	14
<b>7</b>	<b>MALFUNCTIONS, CAUSES AND REMEDIES</b> .....	<b>16</b>
7.1	TROUBLE-SHOOTING .....	16
7.2	FAULT DIAGNOSIS .....	16
<b>8</b>	<b>TECHNICAL DATA</b> .....	<b>18</b>

**EG-Konformitätserklärung des Herstellers**  
nach der EG-Maschinenrichtlinie 2006/42/EG Anhang II, Nr. 1 A  
**EC-Declaration of Conformity by the Manufacturer**  
as defined by machinery directive 2006/42/EC, Annex II, No. 1 A



MUNSCH Kunststoff-Schweißtechnik GmbH  
Im Staudchen  
D-56235 Ransbach-Baumbach  
Germany

Mr. Johann Dausenau,  
Kunststoffschweißtechnik GmbH,  
is authorised to compile the technical documentation.

We hereby declare that the hand extruders

Machine type:	Hand extruder	Hand extruder
Type designation:	MEK-32	MAK-32

are in accordance with all relevant provisions of the EC Machinery Directive.

The following harmonised standards (or parts of these standards) were applied:

- |   |   |
|---|---|
| <input checked="" type="checkbox"/> <u>DIN EN ISO 12100-1: 2004</u> | <input checked="" type="checkbox"/> <u>DIN EN 13732-1: 2008</u> |
| <input checked="" type="checkbox"/> <u>DIN EN ISO 12100-2: 2004</u> | <input type="checkbox"/> _____                                  |

In addition, the hand extruders are in accordance with the following EC-directives, standards, codes and regulations:

- |   |   |
|---|---|
| <input checked="" type="checkbox"/> <u>EU Low-Voltage Directive 73/23/EC</u>    | <input checked="" type="checkbox"/> <u>EU EMC Directive 89/336/EC</u> |
| <input checked="" type="checkbox"/> <u>EN 60204-1 (VDE 0113 Part 1): 2007</u>   | <input checked="" type="checkbox"/> <u>DIN EN 55014-1: 2007</u>       |
| <input checked="" type="checkbox"/> <u>EN 61029-1 (VDE 0740 Part 500): 2003</u> | <input checked="" type="checkbox"/> <u>DIN EN 55014-2: 2009</u>       |
| <input checked="" type="checkbox"/> <u>VDE 0701 Part 1: 2008</u>                | <input type="checkbox"/> _____  |
| <input checked="" type="checkbox"/> <u>VDE 0702 Part 1: 2003</u>                | <input type="checkbox"/> _____  |

This industrial tool complies with the aforesaid standards insofar as it is used at the contractually agreed conditions. The operator is responsible for this.

In the event of any modifications to the machine/unit or use not as intended, this declaration becomes invalid unless the manufacturer's prior written approval has expressly been given.

Ransbach-Baumbach, 09.11.2012

  
Dipl.-Ing. Stefan Munsch  
Managing Director

# Hand Extruder MEK-32 / MAK-32

---

## 1 General



**These operating instructions must always be available at the place of use of the hand extruder.**

The objective of these operating instructions is to support operators in familiarizing themselves with the hand extruder and in using its functions for the intended service.

These operating instructions provide important information for the safe, workmanlike and economical operation of the hand extruder. Their observance helps avoid danger, minimize repair costs and downtimes, enhance reliability, and extend the service life of the hand extruder.

These operating instructions must be observed by all persons working with/on the hand extruder. Such work includes, for instance:

- operation,
- maintenance, inspection and repair
- transport.

The hand extruder may only be mounted, operated and maintained by trained personnel.

In addition to the operating instructions and the national and local accident prevention regulations applicable at the place of use, the acknowledged technical rules for safe and proper working practices must be observed.

These operating instructions provide basic information to be observed for operation and maintenance. For this reason, it is imperative that they be read by the specialist personnel/Operator prior to placing the hand extruder in service and that they always be available at the place of use.

Apart from the general safety instructions under section "Safety", also the special safety instructions given under the respective sub-sections must be adhered to.



**Non-observance of the safety instructions may cause hazards to persons and the environment or damage to the hand extruder.**

Moreover, failure to observe the safety instructions may lead to the forfeiture of any damages.

Non-observance of the safety instructions may in particular involve the following risks:

- failure of important hand extruder functions,
- hazards to persons due to electrical and mechanical impacts including risk of burns,
- hazards to the environment due to vapour-phase hazardous substances,
- risk of fire.

## 2 Safety

These operating instructions provide basic information to be observed for operation and maintenance. For this reason, it is imperative that they be read by the specialist personnel/Operator prior to placing the hand extruder in service and that they always be available at the place of use.

Safe operation of the hand extruder presupposes that the instructions under section 1 – General – of these operating instructions are complied with. In no case must the limit values indicated be violated.

Intact and unaltered hand extruders conform to the applicable codes and standards and meet all regulatory limit values regarding EMC (electromagnetic discharges and interference immunity). For the country-specific limit values to be observed, the Operator should consult the local electric utility. Nevertheless, the hand extruders emit electromagnetic fields within the acceptable limits. Electromagnetic fields may interfere with the operation of vital electronic devices (e.g. cardiac pacemakers). Persons wearing a cardiac pacemaker should therefore consult their physician before using the machine.

In addition to the operating instructions and the national and local accident prevention regulations applicable at the place of use, the acknowledged technical rules for safe and proper working practices must be observed.

Apart from the general safety instructions under section "Safety", also the special safety instructions given under the respective sub-sections must be adhered to.

Any working practices posing a safety risk are prohibited.

## 2.1 Identification of information in the operating instructions

In these operating instructions, safety instructions whose non-observance may cause hazards to persons are identified with



Hazard symbol according to DIN 4844 – W 9

for general hazards and with



Hazard symbol according to DIN 4844 – W 8

for electrical hazards.

Safety instructions whose non-observance may cause damage to the hand extruder and its functions are marked with

**CAUTION**

Instructions directly indicated on the hand extruder must be strictly followed and kept in a fully legible state.

## 2.2 Personnel qualification and training

The operating, maintenance and inspection personnel must possess appropriate qualification for the work to be performed. Functional and technical responsibilities and supervision of the operating personnel must be clearly regulated by the Operator. Where the personnel do not have the necessary skills and knowledge they must be trained and instructed (e.g. a DVS basic welder training in extrusion welding). A detailed instruction into hand extruder operation will be provided by the Manufacturer/Supplier on request. Furthermore, the Operator has to make sure that the contents of the operating instructions is fully understood by the operating personnel.

## 2.3 Risks resulting from non-observance of the safety instructions

Non-observance of the safety instructions may cause hazards to persons and the environment or damage to the hand extruder. Moreover, failure to observe the safety instructions may lead to the forfeiture of any damages.

Non-observance of the safety instructions may in **particular** involve the following risks:

- failure of important hand extruder functions,
- hazards to persons due to electrical and mechanical impacts including risk of burns,
- hazards to the environment due to vapour-phase hazardous substances,
- risk of fire.

## 2.4 Safe working practices

The safety instructions given in these operating instructions, the applicable national accident prevention regulations and any existing in-company work instructions, operating and safety procedures issued by the Operator must be followed.

## 2.5 Safety instructions for Operator / operating personnel

- Before placing the hand extruder in service, check the mains voltage and frequency against the data indicated on the type tag. The allowable tolerances are  $\pm 5\%$  for voltage and/or  $\pm 2\%$  for frequency.
- According to VDE 0100 §55, the hand extruder must be operated via a residual current-operated circuit breaker or an isolating transformer.
- **CAUTION** During hand extruder operation (under load), a voltage of not less than 230 V<sup>1)</sup> must be available at the connector of the hand extruder.
- When using an extension cable, make sure to observe the minimum conductor cross-section. Use extension cables with protective conductor only.

Length [m]	Minimum cross-section [mm <sup>2</sup> ]
up to 19	4.0 <sup>1)</sup>
20-50	6.0 <sup>1)</sup>

1) for 230 V AC

# Hand Extruder MEK-32 / MAK-32

- Extension cables must be certified for the specific service conditions (e.g. outdoor service) and identified accordingly.

Always handle the connecting cable with care.

- Do not kink the connecting cable.
- Do not place any objects on the cable.
- Do not jam or squeeze the connecting cable, nor pull it over sharp edges.
- Protect the connecting cable from moisture.

-  Do not touch the mains connector or connecting cable with wet hands. Hold the cable always at the connector when plugging or unplugging it.

- **CAUTION** Power generator sets used for power supply must be designed for the following rated output:

≥ 4 x rated output of hand extruder

-  Never allow the hand extruder to come into contact with water: Hazard to persons and equipment, short-circuit risk.

- **CAUTION** Never operate the hand extruder without air supply; risk of hand extruder damage.

When using an external air source, make sure that the air supply line is adequately dimensioned.

- **CAUTION** The supply air must be clean, dry and free from oil and water.

-  The hand extruder must not be used in explosion hazard areas or flammable atmospheres.

Make sure that the hand extruder is firmly positioned during the extrusion welding job.

The connecting cable, welding rod and hose for external air supply, if applicable, must be freely movable and must not obstruct the operator or third parties in their work.

-  Hold and touch the hand extruder only on the handles provided for this purpose.

- **Do not** touch bare metal parts (including hot air hood) either with or without gloves. These parts reach temperatures of up to 350 °C.
- Attachments may be damaged or impaired in their function if subjected to the full weight of the hand extruder.
- Bare metal parts must not come into contact with other items during the work or work breaks (e.g. cooling).

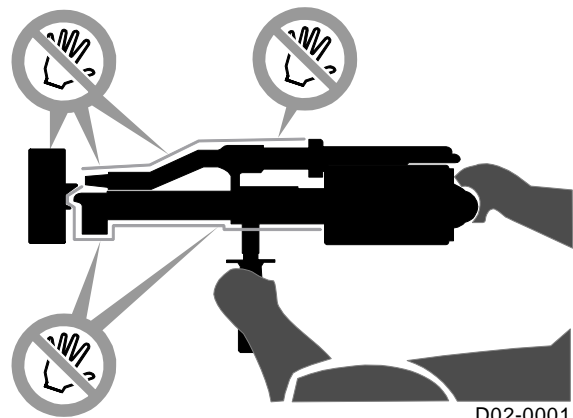

-  Contact of combustible components with hot bare metal parts poses a risk of fire!

**Do not use synthetic gloves!**

- Do not direct the hot air jet of the hand extruder towards living beings or temperature-sensitive items.

Safety distance: 2 m radius

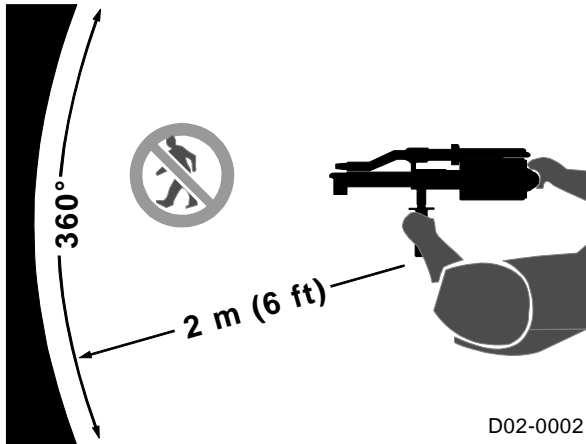

D02-0002

- Use suitable personal protection equipment for overhead work (e.g. hard hat, safety goggles, gloves, protective clothes ...) to guard against falling items.
- During work breaks and after completion of the welding job, place the hand extruder on the rests supplied for this purpose.



**CAUTION** The hot air hood must be remounted.



Make sure that the hand extruder is firmly positioned!

Deposit the hand extruder in a dry location.

After completion of the welding job, cool the hand extruder to safe-to-touch temperature, using the air supply system.

-  Do not operate, dismantle or carry out any modifications on the hand extruder, if
  - the connecting cable or the mains connector is defective,
  - safety devices are damaged,
  - foreign matter or liquid has penetrated into the hand extruder,
  - the unit does not work properly or there are unusual changes in its operating behaviour.
-  Never allow the hand extruder to come into contact with water: Hazard to persons and equipment, short-circuit risk.

## 2.6 Safety instructions for maintenance, inspection and mounting

The Operator is responsible for ensuring that maintenance, inspection and mounting activities are performed by authorized and **qualified personnel** who are thoroughly familiar with the operating instructions.

- As a rule, the hand extruder must be shut off and the connector unplugged before proceeding to any work on the unit. The shutoff procedure for the hand extruder described in the operating instructions must be strictly observed.
- Electrical hazards must be ruled out (for details, see VDE guidelines and the standards of your local electric utility, for instance).



- VDE 0701 (IEC 335) prescribes the measurement of the protective conductor resistance, insulation resistance and leakage current after each repair or modification to electrical equipment. Furthermore, a visual inspection of the unit and its connecting cable as well as voltage and current measurements and a function test must be carried out.
- Ensure the safe and environmentally compatible disposal of media, auxiliary materials and replaced parts!
- Remount and reactivate all safety and protective devices immediately on completion of the maintenance, inspection or repair work.

## 2.7 Unauthorized modifications and spare parts

Modifications or changes to the unit are only allowed after consultation with the Manufacturer. In the interest of safety, only original spare parts and accessories authorized by the Manufacturer should be used. The use of components other than the original spare parts may invalidate the Manufacturer's liability for any resulting damage.



# Hand Extruder MEK-32 / MAK-32

## 3 Transport and Storage

### 3.1 Transport

- ⚠ Before transport and storage, make sure that the hand extruder has cooled down to safe-to-touch temperature.

- ⚠ Hold and touch the hand extruder only on the handles provided for this purpose.

**Do not** touch bare metal parts (including the hot air hood) – whether with or without gloves - before having made sure that they are safe to touch. These parts reach temperatures of up to 350 °C during operation.

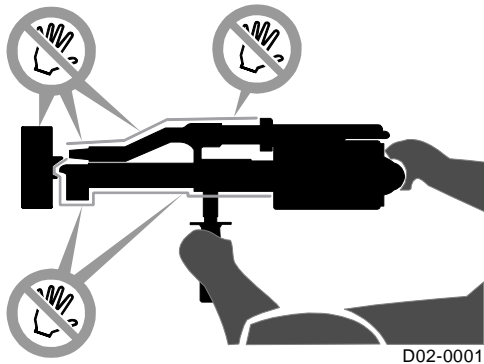

- Always transport or store the hand extruder in such a way as to preclude any mechanical loads on the attachments.

If parts have been removed for transport purposes, mount and fasten them carefully before restarting the hand extruder!

Transport of the hand extruder in MUNSCH's original shipping case is recommended.

### 3.2 Storage

- Store the hand extruder in a dry and frost-free place.
- Protect the hand extruder from unauthorized access.
- Special preservation is not required

### 3.3 Return to Munsch

Should it become necessary to return the hand extruder to MUNSCH Kunststoff-Schweißtechnik GmbH, always use the original shipping case.

## 4 Product Description

### 4.1 Application range

The application range of the hand extruder is defined by the data on the type tag and the service limits indicated in these operating instructions.

**CAUTION** Operation of the hand extruder outside the service limits stated in these operating instructions is subject to the manufacturer's prior approval.

### 4.2 General

Type **MEK** is a hand extruder with external air supply.

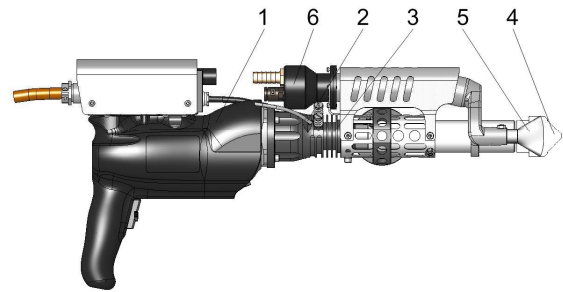

Type **MAK** is a hand extruder with integrated air supply (Autoair).

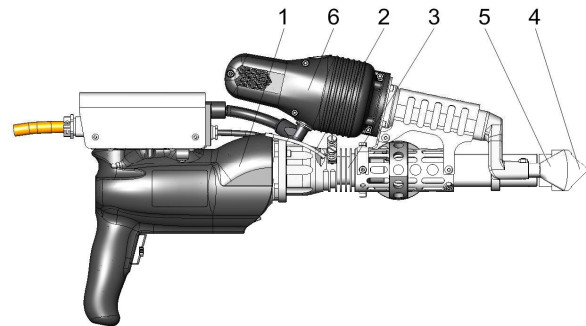

For both types of hand extruder, the following parameters can be freely selected:

- welding rate,
- hot air temperature,
- melt temperature and throughput; the melt throughput can be controlled downward from the maximum value, **firstly** by using 3 mm instead of 4 mm welding rod and, **secondly**, by reducing the speed on the controller.

**CAUTION** Too low a speed will cause a risk of drive overheating!



Driven by a powerful electric motor (1), the welding rod (2) is fed into the extruder (3) and granulated by the extruder screw in the process. The screw forces the granulate into the extruder nozzle, melting it into a homogeneous, completely plastified mass. As the molten material exits the extruder nozzle, it is moulded by a welding shoe (4) to the geometry of the weld seam to be deposited.

Preheating of the base material to be joined is accomplished by a preheating nozzle (5) which is supplied from an integrated hot air unit (6). Air is supplied either from an external compressor or an on-board blower.

Melt and preheat temperatures are controlled separately. The setpoint and momentary values are displayed concurrently.

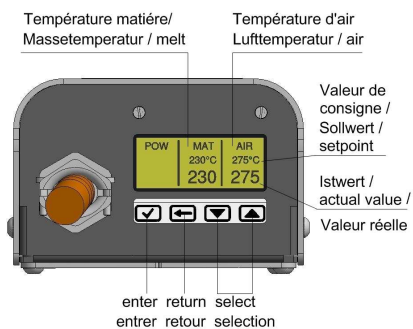

The melt temperature must have reached the preset **start interlock temperature** for the startup timer to be activated. After the startup timer has timed out, the start interlock will be released and the extruder can be started.

The temperature-controlled start interlock prevents the drive from starting if there is still unmolten material in the extruder, thus precluding damage to the unit.

The output rate is variable so that the preheat temperature can be matched to the weld thickness.

## 5 Startup and Shutoff

### 5.1 General

In addition to the operating instructions and the national and local accident prevention regulations applicable at the place of use, the acknowledged technical rules for safe and proper working practices must be observed.

Any working practices posing a safety risk are prohibited.

Before starting / shutting off the hand extruder, make sure to carefully read the instructions under section "Safety".

**Only trained and qualified personnel may be assigned to the operation of the hand extruder.**

### 5.2 Preparation

- Place the hand extruder on a firm support and secure it against toppling over.



- Mount hot air hood

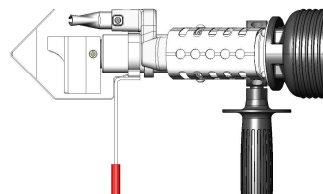

- Position handle  
Loosen handle (55) and move it to the ideal working position by pushing it back and forth. The handles of these extruder models can also be swivelled upward and downward, so that the machine can be operated by both right-handed and left-handed persons.
- Only for MEK hand extruder with external air supply:**

Connect the hand extruder to the external air source using the hose coupling LW 13 / NM 7.2 provided for this purpose (quick connect-disconnect); set air rate to 300 l/min at 0.4 bar. A suitable controller with flow metering function is recommended for setting the air rate.

**CAUTION** The supply air must be clean, dry and free from oil and water.

Never connect an external air source to a MAK hand extruder.

# Hand Extruder MEK-32 / MAK-32

- Mount welding shoe
  - Select the welding shoe required for the specific weld geometry or machine a welding shoe blank to the required geometry.
  - Observe DVS 2207 Guideline, Part 4 for machining welding shoe blanks.
  - Mount welding shoe to the hand extruder in the position required for welding.

**Observe welding direction!**  
Tighten set screw (25).

- Mount preheat nozzle
  - Select and mount the preheat nozzle (4) required for the specific weld geometry.
  - Observe spacing  $A = 5 \text{ mm}$ .
  - Tighten the preheat nozzle using set screw (25.1).

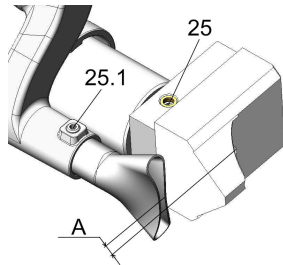

**Table: Preheat nozzle**

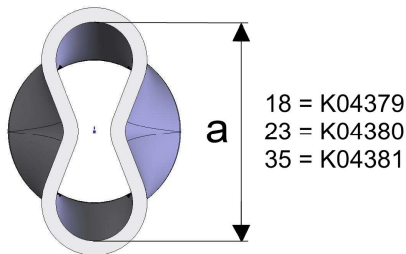

Care must be taken to ensure that the preheat nozzle provides intensive and uniform preheating (melting) of the base material over the entire joint width at as low a hot air temperature as possible. For larger weld seam widths, a wider preheat nozzle is available as an accessory.

## 5.3 Starting the hand extruder



Observe section "Safety".

- **CAUTION** Never operate the hand extruder without air supply. Otherwise the unit may suffer severe damage.
- **CAUTION** Before plugging in the mains connector, check that the drive unit is not set to continuous operation.

- **CAUTION** The hot air hood must be in place.

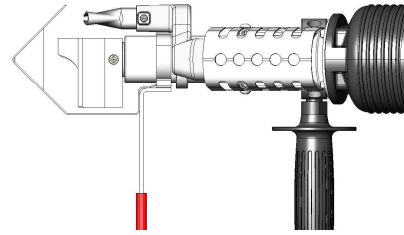

- **CAUTION** Start external air supply for MEK hand extruder.
- **CAUTION** Plug in mains connector.
- **CAUTION** In the case of the MAK hand extruder with integrated air supply, the blower must start automatically.
- **CAUTION** Once air exits the preheat nozzle (4), the heating systems for the air/melt temperatures may be activated.

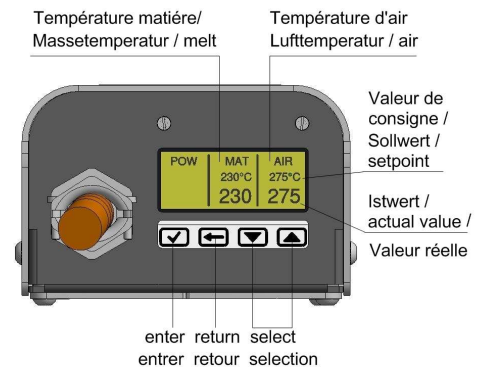

- For the operation of the temperature controller, see section 5.5 "Set temperatures". For temperature settings, see page 12.
- **The hand extruder will reach its operating temperature after about 10 to 15 minutes.**

-  Hold and touch the hand extruder only on the handles provided for this purpose.

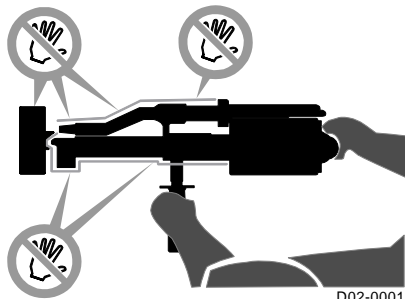

- CAUTION** The melt temperature must have reached the preset **start interlock temperature** for the startup timer to be activated. After the startup timer has timed out, the start interlock will be released and the extruder can be started.

#### 5.4 Welding with the hand extruder

-  Observe section "Safety" and the data sheet.

##### General

Welding is to be carried out in accordance with the guidelines of the German Association for Welding Technology (Deutscher Verband für Schweißtechnik DVS).

The parts to be joined and the welding rod must be clean and dry.

##### 5.4.1 Introducing the welding rod

- CAUTION** The hand extruder is provided with a bore for introducing the welding rod.

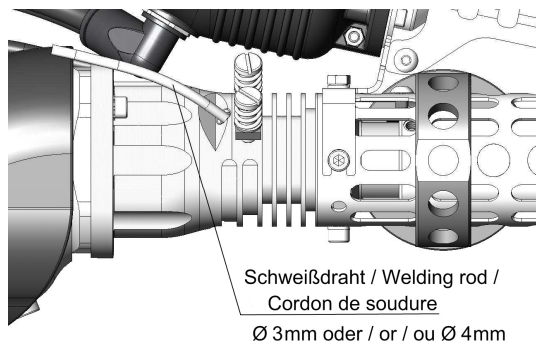

##### 5.4.2 Replacement and aging of welding rod

- If the welding rod is to be replaced, make sure that any remaining rod in the hand extruder is completely removed.
- For this purpose, operate the preheated hand extruder with the new welding rod until clean new material discharges.
- The DVS guideline also recommends this procedure for hand extruders which have been out of service for prolonged periods while still being filled with welding rod.
-  Ensure safe and environmentally compatible disposal of any waste generated.

##### 5.4.3 Welding direction / rate

- The pressure of the discharging extrudate causes the welding shoe (and hence, the hand extruder) to move in welding direction.
- See DVS Guidelines for the welding rate.

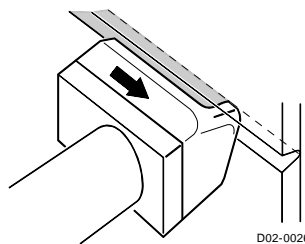

##### 5.4.4 Interruption of work

-  Observe section "Safety".  
Do not leave the hand extruder unattended.  
Make sure to maintain the air supply.
- When interrupting the welding job, switch off the drive unit and deposit the hand extruder as shown in the illustration below.



# Hand Extruder MEK-32 / MAK-32

## 5.4.5 Shutoff



Observe section "Safety".

- After completion of the welding job, switch off the drive unit and deposit the hand extruder as shown in the illustration (see preceding section).



Do not leave the hand extruder unattended.

### 5.4.5.1 Hand extruder with integrated air supply, type MAK

- Press "return" button once to switch off the heating circuits.

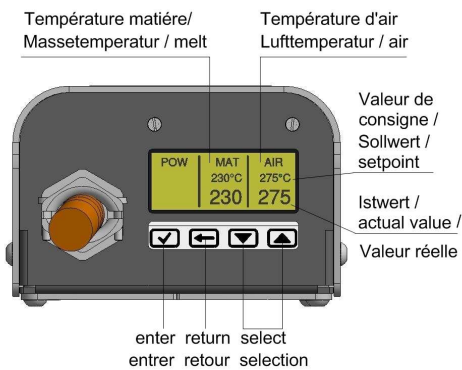

- Maintain the air supply of the hand extruder until the unit has completely cooled down!
- Pull mains connector.

### 5.4.5.2 Hand extruder with external air supply, type MEK

- Press "return" button once to switch off the heating circuits.
- Pull mains connector.

- Maintain the air supply of the hand extruder until the unit has completely cooled down!



**Never use water or another coolant to accelerate the cooling process!**

## 5.4.6 Transport/Storage

Make sure to observe the instructions under section "Transport/Storage".

## 5.5 Set temperatures on temperature controller

The default settings for the melt and air temperatures of the MEK and MAK hand extruders are shown in the following temperature chart.

(The values have been determined with the aid of reference materials.)

### Temperature chart for MEK/MAK

Material	Melt temperature	Air temperature
PP	200 – 240 °C	250 – 300 °C
PE	200 – 240 °C	250 – 300 °C
PVDF	240 – 260 °C	280 – 350 °C

If other temperatures are needed the corresponding settings can be made on the temperature controller.

## 5.5.1 Set temperatures

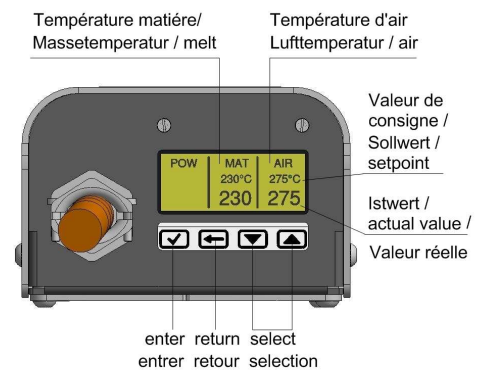

**Operating Instructions MUNSCH-controller (MA/EK-18-32) from Software 1v56 onwards  
Bedienungsanleitung MUNSCH-Regler (MA/EK-18-32) ab Software 1v56**

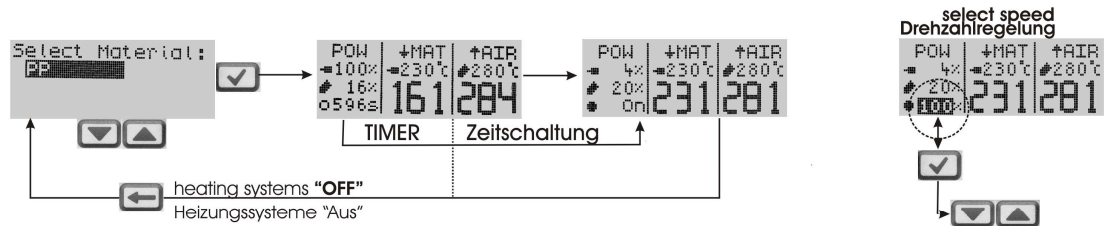

**melt temperature / Masse Temperatur**



**air temperature / Luft Temperatur**

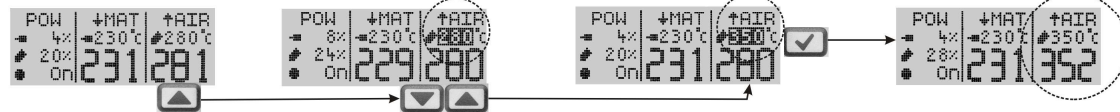

**Display design / Display Beschreibung**

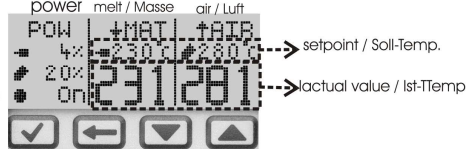

- ENTER push-button and push-button for Select Speed: Bestätigungstaste und Taste zur Änderung der Motordrehzahl
- RETURN push-button and push-button for switch off heating systems! : Zurücktaste und Ausschalten der Heizsysteme
- DOWN push-button (Menue) and SELECT MELT for change the melt-temperature: Runter - Taste zur Änderung der Massestemperatur
- UP push-button (Menue) and Select AIR for change the air-temperature: Hoch - Taste zur Änderung der Lufttemperatur

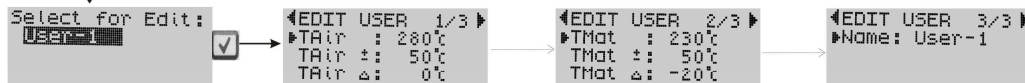
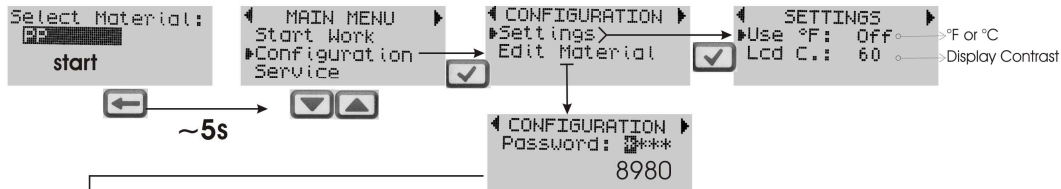

Bei den User-Menüs (1, 2, 3 und 4) sind alle Positionen frei programmierbar.  
In User-Menüs (1, 2, 3 und 4) are all positions complete free programmable.



Bei den Hauptmenüs (PP, PE, PVDF und PVC-U) können nur die Abgleichwerte verändert werden!  
In the main-menus (PP, PE, PVDF and PVC-U) only the setoff's changeable.

**TAir Δ: 0%** Abgleich der Luft und Masse Temperaturen / Calibration from air and melt temperature:

- Messung der Temperatur mit externem Thermometer ist: measuring of temperature with external temperature probe is:
- zu kalt, den Abgleich in den PLUS Bereich verschieben! - too cold, shift comparison into PLUS area!
- zu warm, den Abgleich in den MINUS Bereich verschieben! - too hot, shift comparison into MINUS area!

**Notizen / Abgleiche user 1 - 4**

**notes / configuration user 1 - 4**

TAir	TAir Δ	TAir Δ	TMat	TMat Δ	TMat Δ	Name: User



# Hand Extruder MEK-32 / MAK-32

## 6 Maintenance/Inspection



Pull mains connector before carrying out any maintenance and repair work on the hand extruder.

Maintenance and repair work on electrical tools may only be carried out by qualified electricians.



The hand extruder together with the hot air hood must have cooled down to safe-to-touch temperature.

Observe the instructions under section "Safety".

Maintenance and repair work may only be carried out by qualified personnel or by our service staff.

To ensure the proper function of the hand extruder over its entire service life for its intended service, we recommend:

- to have all maintenance, inspection and mounting work carried out by authorized and qualified personnel who are familiar with the operating instructions,
- to always shut off the unit before carrying out any work on it,
- to remount and reactivate all safety and protective devices immediately after completion of the maintenance/repair work.

During maintenance and repair work, make sure that the hand extruder and its individual components are firmly positioned.

In addition to the operating instructions and the national and local accident prevention regulations applicable at the place of use, the acknowledged technical rules for safe and proper working practices must be observed.

Any working practices posing a safety risk are prohibited.



Activities other than those described in this section may only be performed at the Manufacturer's workshops!

### 6.1 Maintenance/inspection of MEK/MAK hand extruder

- **CAUTION** After approx. 500 operating hours, the hand extruder including drive unit must be thoroughly cleaned and inspected. This work may only be carried out at the manufacturer's workshops.
- **CAUTION** Cables, switches, plug-in connections must be inspected by qualified staff every three months (requirement according to VBG4); the inspection results must be documented!

### 6.2 Dismantling

Prior to dismantling the hand extruder, pull the mains connector.

The hand extruder must be at ambient temperature.

Damaged mains connection cables must be completely replaced. "Mended" cables pose a hazard to life and limb. Cable replacement is to be carried out by qualified electricians only.

The safety precautions described under sections "Safety" and "Malfunctions, Causes and Remedies" must be strictly adhered to.

#### 6.2.1 Overview of spare parts/attachments

**When ordering spare parts, always indicate the serial number of the extruder.**

Make sure to use original spare parts only.

For spare parts supply, contact MUNSCH Kunststoff-Schweißtechnik GmbH.

Drive unit UX1 – Replace carbon brushes:

Remove the 3 screws and pull off the cap. Remove dirt / carbon dust using compressed air, for instance. Replace carbon brushes (2 x K04886) and screw the cap in place again.

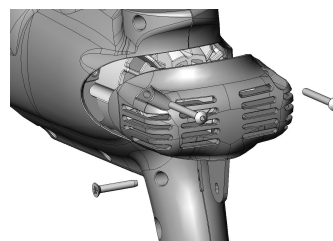

Extruder screw bearing:

- K03701 = Axial bearing (replace)
- K03702 = Ball bearing (replace)
- K03703 = Circlip (replace, if necessary)
- K03704 = Seal ring (replace)
- K04080 = Spacer ring (replace, if necessary)

Compression lever assembly  
Baugruppe Druckhebel 18, 25, 32

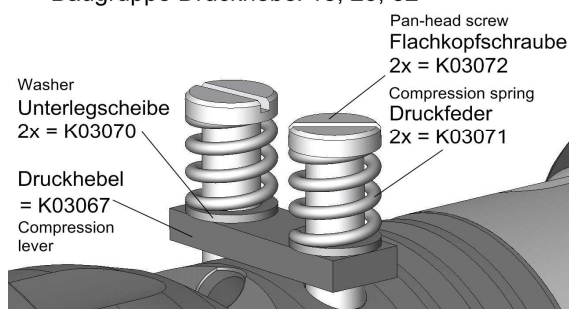

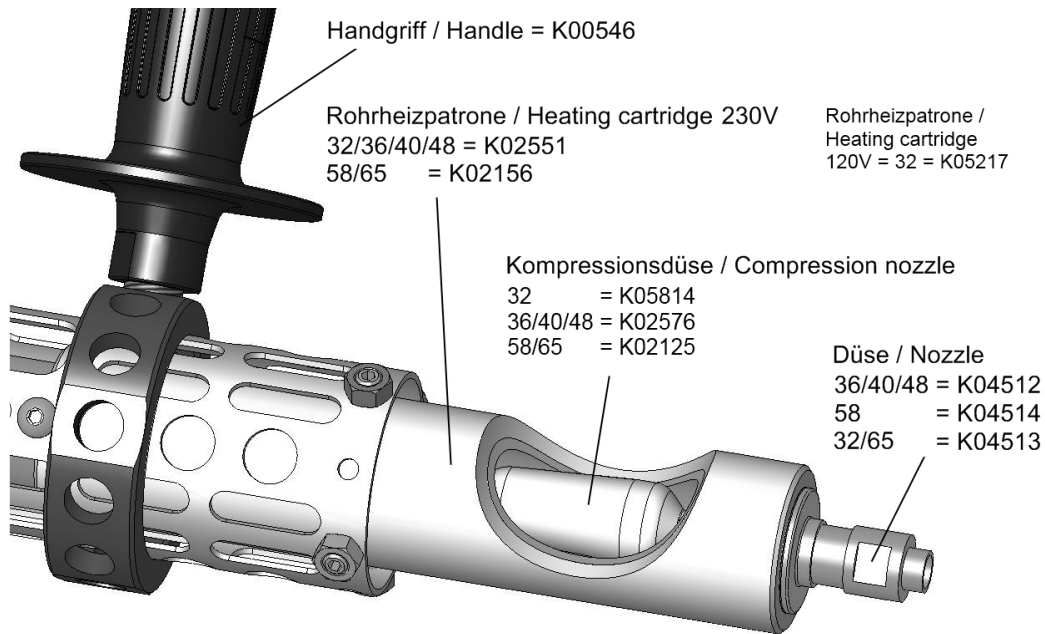

Schaltgehäuse - Unterteil mit Regler Typ K  
Control box - bottom part with controller type K

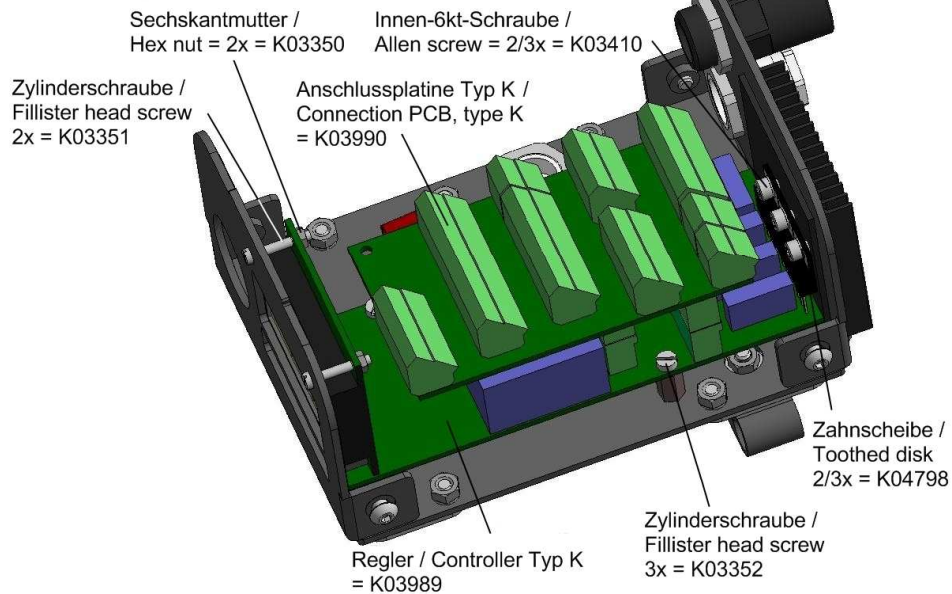

On-board blower Eigenluftgebläse; MEG-23, 230 V = K04202  
Eigenluftgebläse; MEG-17, 120V = K04203

Handle / Griffschale = K04198

Electronic unit / Elektronikeinheit, 230V = K04232  
120V = K04233

Ceramic heating element / Heizung Keramik, 230V = K04234  
120V = K04235



Luftherhitzer / Air preheater  
MLE-23, 230V = K04552

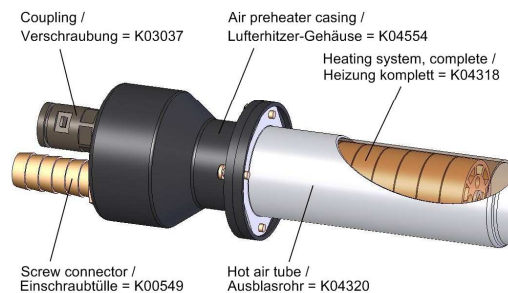



# Hand Extruder MEK-32 / MAK-32

## 7 Malfunctions, Causes and Remedies

### 7.1 Trouble-shooting

The following table lists potential operating upsets of the hand extruder, possible causes and their remedies (fault diagnosis chart).

Should malfunctions occur which are not covered here or which cannot be traced back to the cause stated, please contact MUNSCH Kunststoff-Schweißtechnik GmbH.

Malfunction	Fault No.
Drive motor does not start	5, 8, 9, 10, 11, 12, 14, 15, 16, 17, 18, 19, 23
Drive motor switches off	5, 8, 9, 10, 11, 12, 14, 15, 16, 17, 18, 19, 23
No welding rod feed	1, 16, 17, 20
No extrudate conveyed out of welding shoe	1, 16
Extrudate output decreases during operation	1, 14, 16
No air supply	6, 7, 13
Integrated air supply without function	5, 22
No hot air	2, 3, 4, 5, 6, 18, 22
Hot air temperature below setpoint temperature	2, 3, 4, 8, 10, 18, 22, 14
Melt temperature below setpoint temperature	2, 3, 9, 11, 14
Extruder does not heat up	2, 3, 12, 22
Temperature above preset range	2, 3, 18, 19
Controller fault signal: E	2
Controller fault signal: OEAIR	2, 13, 22
Controller signal: OFF	9, 10, 11, 12
Control fluctuates	3, 13, 19, 12



### 7.2 Fault diagnosis

Fault No.	Possible causes	Remedies
1	Smaller or too small a welding rod diameter	Use larger welding rod diameter, if necessary
2	Temperature sensor defective	<sup>1)</sup>
3	Temperature controller defective	<sup>1)</sup>
4	Air rate too high	Reduce air rate to specified level <sup>3)</sup>
5	Cable connections defective	Check cable connections <sup>1)</sup>
6	External air supply not connected <sup>3)</sup>	Connect external air supply
7	External air supply without function <sup>3)</sup>	Switch on external air supply  Check the external air supply system for malfunctions using the separate manual, or have it checked.
8	Hot air temperature below start interlock temperature	Allow hand extruder to heat up Air rate too high → reduce air rate <sup>3)</sup>

1) Consult MUNSCH Kunststoff-Schweißtechnik GmbH

2) Only for MAK

3) Only for MEK

Fault No.	Possible causes	Remedies
9	Melt temperature below start interlock temperature	Allow hand extruder to heat up
10	Preheat time for hot air too short	Allow hand extruder to heat up
11	Preheat time for melt too short	Allow hand extruder to heat up
12	Heating cartridge defective	<sup>1)</sup>
13	Air supply not constant	- External air supply: - Check air supply unit <sup>3)</sup>  - Integrated air supply: <sup>1)</sup>
14	Wrong rated voltage	<b>Rated voltage &gt; permissible voltage</b> Check mains voltage  <b>Rated voltage &lt; permissible voltage</b> Check mains voltage <sup>1)</sup>
15	Extension cable heats up	- Unroll cable reel - Check cable cross-section (see also section "Safety")
16	Extruder nozzle plugged with foreign matter	Clean extruder.   <b>Extruder nozzle – left-hand thread</b>
17	Drive unit defective	<sup>1)</sup>
18	Electronic control defective	<sup>1)</sup>
19	Controller programming error	<sup>1)</sup>
20	Welding rod feed	Remove welding rod   Observe instructions in section "Maintenance"!  Observe instructions for operation!
22	Hot air unit defective	<sup>1)</sup>
23	No mains voltage	Check voltage supply

1) Consult MUNSCH Kunststoff-Schweißtechnik GmbH

2) Only for MAK

3) Only for MEK

# Hand Extruder MEK-32 / MAK-32

## 8 Technical Data

Type designation	MEK	MAK
<b>Welding materials</b>	PP, PE, PVDF	PP, PE, PVDF
<b>Welding rate, approx.</b>	<b>32</b> = Ø 3 mm: 1.8 kg/h PP/PE <b>32</b> = Ø 4 mm: 3.2 kg/h PP/PE	<b>32</b> = Ø 3 mm: 1.8 kg/h PP/PE <b>32</b> = Ø 4 mm: 3.2 kg/h PP/PE
<b>Welding rod</b>	Welding rod Ø 3 and 4 mm	Welding rod Ø 3 and 4 mm
<b>Application range</b>	<b>32</b> = Wall thicknesses 8-30 mm and film/sheeting welds	<b>32</b> = Wall thicknesses 8-30 mm and film/sheeting welds
<b>Weight</b>	<b>32</b> = 7.6 kg	<b>32</b> = 7.8 kg
<b>Drive</b>	230 V AC with speed control	230 V AC with speed control
<b>Extruder heating system</b>	<b>32</b> = 650 W / 230 V	<b>32</b> = 650 W / 230 V
<b>Air preheater</b>	2100 W / 230 V	2300 W / 230 V
<b>Air supply</b>	External air source	Integrated air supply
<b>Air rate</b>	300 l/min at 0.4 bar	-----
<b>Control of melt temperature</b>	Temperature controller with concurrent momentary value and setpoint display	Temperature controller with concurrent momentary value and setpoint display
<b>Control of air temperature</b>	Temperature controller with concurrent momentary value and setpoint display	Temperature controller with concurrent momentary value and setpoint display
<b>Cold start protection</b>	Start temperature interlock and startup timer for melt and preheat air	Start temperature interlock and startup timer for melt and preheat air

# Warranty Certificate

.....  
.....  
.....

Name and address of Purchaser

**Type of unit:** Hand extruder

**Type designation:**

**Serial No.:**

**P.O. No.:**

## Your warranty

MUNSCH Kunststoff-Schweißtechnik GmbH hereby warrants the unit to be free from defects in materials and workmanship from the date of its first acquisition. Should deficiencies resulting from defects in materials or workmanship be identified during the warranty period, the dealers will, in accordance with the following terms and conditions, repair the unit or, at their discretion, replace either the complete unit or the defective components without charging labour or material costs.

.....  
Dealer's stamp and signature

# Hand Extruder MEK-32 / MAK-32

---

## Warranty

- 1 The Manufacturer warrants freedom from defects in materials and workmanship and state-of-the-art performance of the purchased article for a period of six (6) months from the date of delivery.
- 2 The Purchaser shall check the article delivered for completeness and freedom from defects immediately after receipt.
- 3 The Purchaser shall be entitled to the making good of defects and any resulting damage to other parts of the purchased article (remedial work).  
The procedure for claims under this warranty shall be as follows:
  - 3.1 The Purchaser may assert claims under this warranty either with his dealer or with a company authorized by the Manufacturer to provide services for the purchased article. The Purchaser shall give written notice of defects to the respective company promptly after such defects have been identified or shall have such defects registered by the respective company.
  - 3.2 Defects shall be promptly remedied in accordance with the technical requirements by either replacement or repair of the defective parts, the cost of the remedial work being for the account of the Manufacturer. Replaced parts shall become the property of the Manufacturer.  
If, as a result of the remedial work, additional maintenance measures are prescribed by the Manufacturer, the resulting costs including the costs of materials and lubricants shall be for the Manufacturer's account.
  - 3.3 For replacement parts installed within the scope of the remedial work, a warranty will be provided under the purchase contract, the warranty period for such parts ending on expiry of the warranty period of the object purchased.
  - 3.4 For the warranty to become effective, this warranty certificate must be produced for each repair.
- 4 If the defect cannot be remedied or if the Purchaser cannot be reasonably expected to accept any further attempts at making good the defect, the Purchaser may demand annulment (cancellation of the contract) or a price reduction (reduction of compensation) in lieu of remedial work. In such a case, the Purchaser shall not be entitled to any replacement.
- 5 Manufacturer's warranty obligations shall not be affected by a change in ownership of the purchased article.
- 6 Any damage incurred through the following acts or omissions of Purchaser shall be **expressly excluded** from this warranty:
  - 6.1 Purchaser's failure to report a defect pursuant to subsection 3.1 or to promptly provide an opportunity to remedy the defect following Manufacturer's request, or
  - 6.2 improper handling or overload operation of the purchased article, or
  - 6.3 prior repair, maintenance and servicing of the purchased article by a company not authorized by the Manufacturer, if the Purchaser can be reasonably expected to have known that such company was not authorized, or
  - 6.4 the installation of parts into the purchased article without having obtained Manufacturer's prior approval for such parts or the modification of the purchased article in a way not approved by the Manufacturer, or
  - 6.5 Purchaser's failure to observe the instructions given in the user's manual accompanying the purchased article (e.g. operation, maintenance and care), or
  - 6.6 Purchaser having removed the serial number or made it illegible.
- 7 Natural wear and tear shall be expressly excluded from this warranty.
- 8 Accidents, force majeure or other circumstances beyond the control of the Manufacturer, in particular damage caused by lightning, overvoltage, water, fire, etc. shall be excluded from this warranty.
- 9 All rights under this warranty shall become null and void on expiry of the warranty term pursuant to Section 1. For claims asserted within the warranty term but not settled by its expiry, the warranty shall remain effective until the respective defect has been remedied. The period of limitation shall be suspended for such claim.

## MUNSCH Kunststoff-Schweißtechnik GmbH

Im Staudchen • D-56235 Ransbach-Baumbach

P.O. Box 142 • D-56221 Ransbach-Baumbach

Germany

Phone: +49 (0) 26 23-8 98-80

Telefax: +49 (0) 26 23-8 98-85

Internet: <http://www.munsch.de>

Email: [munsch@munsch.de](mailto:munsch@munsch.de)