

Pipes

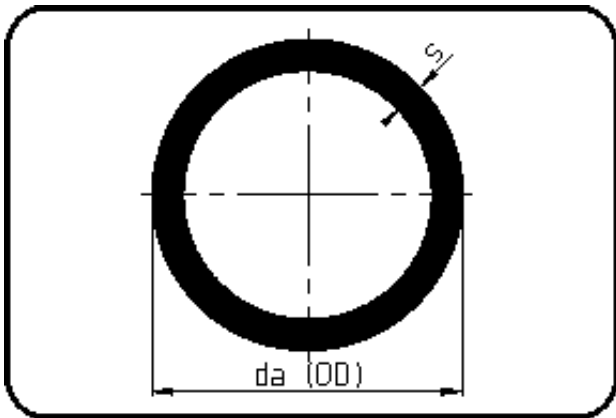

- Pipe 5m
- flame retardant
- extruded
- PPs grey

Dim. 110 - 160 SDR11 Discontinued products.

Dimension	Code	Detail	Weight
40	17.705.0040.11	40X3,7 SDR11 ISO S-5	0.423

	Unit	Nominale	Tol-	Tol+
da(OD)	mm	40		
s	mm	3,7	0	0,6