

Pipes

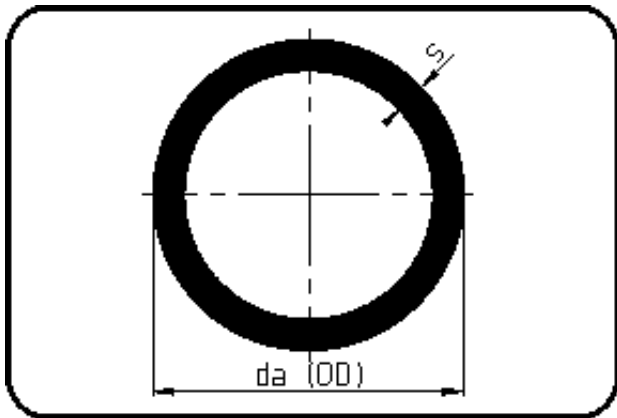

- Pipe 5m
- flame retardant
- extruded
- PPs grey

Dim. 110 - 160 SDR11 Discontinued products.

Dimension	Code	Detail	Weight
20	17.705.0020.11	20X1,9 SDR11 ISO S-5	0.115

	Unit	Nominale	Tol-	Tol+
da(OD)	mm	20		
s	mm	1,9	0	0,3