

Pipes

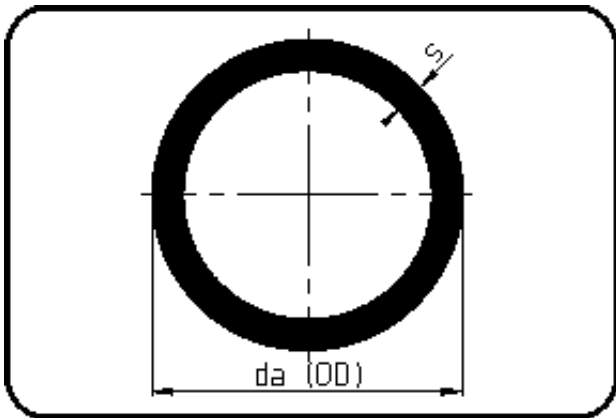

- Pipe 5m
- flame retardant
- extruded
- PPs grey

Dim. 110 - 160 SDR11 Discontinued products.

Dimension	Code	Detail	Weight
32	17.705.0032.11	32X2,9 SDR11 ISO S-5	0.267

	Unit	Nominale	Tol-	Tol+
da(OD)	mm	32		
s	mm	2,9	0	0,5