

Pipes

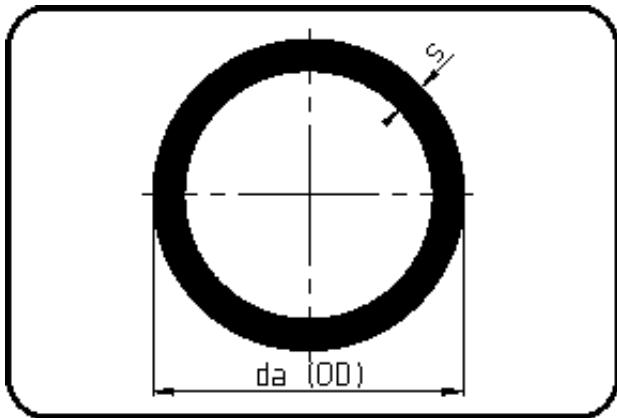

- Pipe 5m
- flame retardant
- extruded
- PPs grey

Dim. 110 - 160 SDR11 Discontinued products.

Dimension	Code	Detail	Weight
50	17.705.0050.11	50X4,6 SDR11 ISO S-5	0.654

	Unit	Nominale	Tol-	Tol+
da(OD)	mm	50		
s	mm	4,6	0	0,7