

Pipes

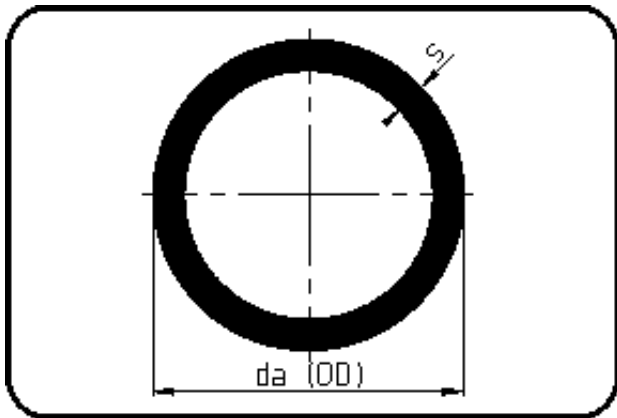

- Pipe 5m
- flame retardant
- extruded
- PPs grey

Dim. 110 - 160 SDR11 Discontinued products.

Dimension	Code	Detail	Weight
90	17.705.0090.41	90X2,2 SDR41 ISO S-20	0.619

	Unit	Nominale	Tol-	Tol+
da(OD)	mm	90		
s	mm	2,2	0	0,5