

Pipes

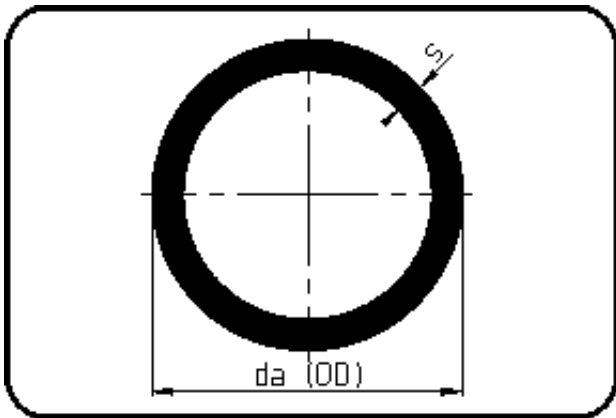

- Pipe 5m
- flame retardant
- extruded
- PPs grey

Dim. 110 - 160 SDR11 Discontinued products.

Dimension	Code	Detail	Weight
63	17.705.0063.11	63X5,8 SDR11 ISO S-5	1.03

	Unit	Nominale	Tol-	Tol+
da(OD)	mm	63		
s	mm	5,8	0	0,8